

## CBT-39-UV LEDs

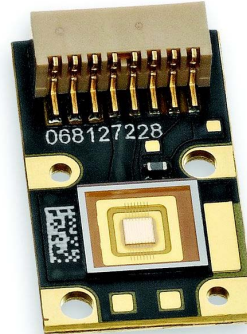

### Table of Contents

Technology Overview .....2

Binning Structure .....3

Ordering Information .....3

Optical & Electrical Characteristics .....4

Optical & Electrical Characteristics Graphs.....5

Optical Spectrum .....7

Thermal Resistance .....8

Mechanical Dimensions .. 10

Change History ..... 11

### Features:

- Chip area 1:1.1 aspect ratio: matched to TI's 0.55" XGA DLP for 3D printing applications
- Low thermal resistance package,  $R_{th,j-c} = 1.6^{\circ}\text{C/W}$
- Typical peak wavelength 405 nm
- 6.6W typical optical power
- Operation at up to 6A DC
- Low-profile window for efficient coupling into optical systems of fibers
- RoHS and REACH compliant

### Applications

- 3D Printing
- Fluorescence imaging
- Ink and adhesives curing
- Spot curing
- Machine vision
- Medical and scientific instrumentation

## Technology Overview

Luminus LED benefit from innovations in device technology, chip packaging and thermal management. This suite of technologies give engineers and system designers the freedom to develop solutions both high in power and efficiency.

### Luminus Technology

Luminus' technology enables large area LED chips to emit photons uniformly over the entire LED chip surface. The intense optical power density produced by these UV LED facilitate designs which replace arc and halogen lamps where arrays of traditional high power LEDs cannot.

For UV devices, Luminus engineers LEDs to maximize light extraction and to emit with a Lambertian far-field distribution pattern. The design maximizes efficiency and allows for flexible optical designs.

### Packaging Technology

Thermal management is critical in high power LED applications. Luminus CBT-39-UV LEDs have the lowest thermal resistance of any LED on the market with a thermal resistance from junction to heat sink of 1.8°C/W. This allows the LED to be driven at higher current densities while maintaining a low junction temperature, thereby resulting in brighter solutions and longer lifetimes.

### Reliability

Designed from the ground up for high power operation, Luminus LEDs are one of the most reliable light sources in the world today. They have passed a rigorous suite of environmental and mechanical stress tests, including mechanical shock, vibration, temperature cycling and humidity, and have been fully qualified for use in extreme high power and high current applications. With very low failure rates and median lifetimes that typically exceed 10,000 hours, Luminus LEDs are ready for even the most demanding applications.

### Environmental Benefits

Luminus LEDs help reduce power consumption and the amount of hazardous waste entering the environment. All LED products manufactured by Luminus are RoHS compliant and free of hazardous materials, including lead and mercury.

## Understanding Luminus LED Test Specifications

Every Luminus LED is fully tested to ensure that it meets the high quality standards expected from Luminus' products.

### Testing Temperature

Luminus core board products are typically measured in such a way that the characteristics reported agree with how the devices will actually perform when incorporated into a system. This measurement is accomplished by mounting the devices on a 40°C heat sink. This method of measurement ensures that Luminus LEDs perform in the field just as they are specified.

### Operating Points

The tables on the following pages provide typical optical and electrical characteristics. The LEDs can be operated over a wide range of drive conditions (currents from <1A to 9.75 A, and duty cycle from <1% to 100%).

CBT-39-UV devices are production specified at 6 A. Any other values shown are for additional reference at other possible drive conditions.

## CBT-39-UV Binning Structure

CBT-39-UV LEDs are specified for radiometric flux and peak wavelength at a drive current of 6 A (1.54 A/mm<sup>2</sup>) and placed into one of the following Power Bins and Wavelength Bins:

### Radiometric Flux Bins<sup>1</sup>

Color	Radiometric Flux Bin (F)	Minimum Flux (W)	Maximum Flux (W)
UV	DA	4.00	4.33
	DB	4.33	4.67
	DC	4.67	5.00
	EA	5.00	5.50
	EB	5.50	6.00
	FA	6.00	6.50
	FB	6.50	7.00
	GA	7.00	7.50
	GB	7.50	8.00

Note 1: Luminus maintains a +/- 6% tolerance on flux measurements.

### Wavelength Bins

Color	Wavelength Bin (123)	Minimum Wavelength (nm)	Maximum Wavelength (nm)
UV	400	400	405
	405	405	410

## CBT-39-UV Ordering Information

Ordering Part Number <sup>2</sup>	Color	Description
CBT-39-UV-C32-DA400-22	UV	CBT-39 -UV consisting of a 3.9 mm <sup>2</sup> LED, with a minimum power of 4W, a wavelength range from 400nm to 410nm, a thermistor, a connector, a window and a copper-core PCB.

Note 2: For ordering information on all available bin kits, please see PDS-002170: CBT-39-UV Binning & Labeling document.

**Reference Optical & Electrical Characteristics ( $T_{hs} = 40^{\circ}\text{C}$ )<sup>1,2</sup>**

UV			
Wavelength		405 nm	
Parameter	Symbol	Values <sup>3</sup>	Unit
Test Current Density <sup>4</sup>	$j$	1.54	A/mm <sup>2</sup>
Forward Voltage	$V_{Fmin}$	3.0	V
	$V_F$	3.5	V
	$V_{Fmax}$	4.2	V
Radiometric Flux <sup>5</sup>	$\Phi_{typ}$	6.6	Ω
Radiometric Flux Density	$\Phi_R$	1.41	W/mm <sup>2</sup>
Wavelength Range	$\lambda$	400 - 410	nm
Centroid Wavelength	$\lambda_p$	405	nm
FWHM	$\Delta\lambda_{1/2}$	15	nm
	Symbol	Value	Unit
Emitting Area		3.9	mm <sup>2</sup>
Emitting Area Dimensions		1.87 x 2.09	mm x mm
Dynamic Resistance	$\Omega_{dyn}$	0.02	Ω

**Absolute Maximum Ratings**

	Symbol	Value	Unit
Minimum Drive Current <sup>8</sup>		0.2	A
Maximum Current CW <sup>6</sup>		6	A
Maximum Current Pulsed <sup>6</sup>		9.75	A
Maximum Junction Temperature <sup>7</sup>	$T_{jmax}$	150	°C
Storage Temperature Range		-40 to +100	°C

Note 1: Data verified using NIST traceable calibration standard.

Note 2: All data are based on test conditions with a constant heat sink temperature  $T_{hs} = 40^{\circ}\text{C}$  under pulse testing conditions. Pulse conditions: 25% duty-cycle and frequency of 720 Hz. Nominal  $T_j \approx 80^{\circ}\text{C}$ . See Thermal Resistance section for  $T_j$  and  $T_{hs}$  definition.

Note 3: Unless otherwise noted, values listed are typical. Devices are production tested and specified at 6 A.

Note 4: CBT-39-UV devices can be driven at currents ranging from <1 A to 6 A and at duty cycles ranging from 1% to 100%. Drive current and duty cycle should be adjusted as necessary to maintain the junction temperature desired to meet application lifetime requirement.

Note 5: Typical total flux from emitting area at listed centroid wavelength. Reported performance is included to show trends for a selected power level. For specific minimum and maximum values, use bin tables. For product roadmap and future performance of devices, contact Luminus.

Note 6: CBT-39-UV LEDs are designed for operation to an absolute maximum current as specified above. Product lifetime data is specified at recommended forward drive currents. Sustained operation at or beyond absolute maximum currents will result in a reduction of device life time compared to recommended forward drive currents. Actual device lifetimes will also depend on junction temperature. Refer to the lifetime derating curves for further information. In pulsed operation, rise time from 10-90% of forward current should be longer than 0.5 μseconds.

Note 7: Lifetime dependent on LED junction temperature. Input power and thermal system must be properly managed to ensure lifetime.

Note 8: Special design considerations must be observed for operation under 1 A. Please contact Luminus for further information.

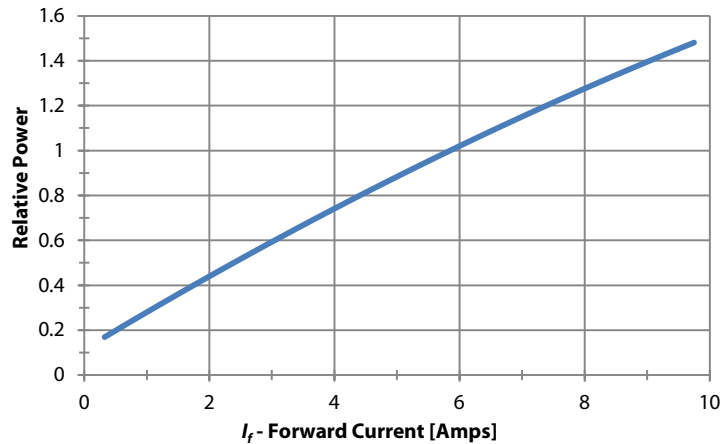
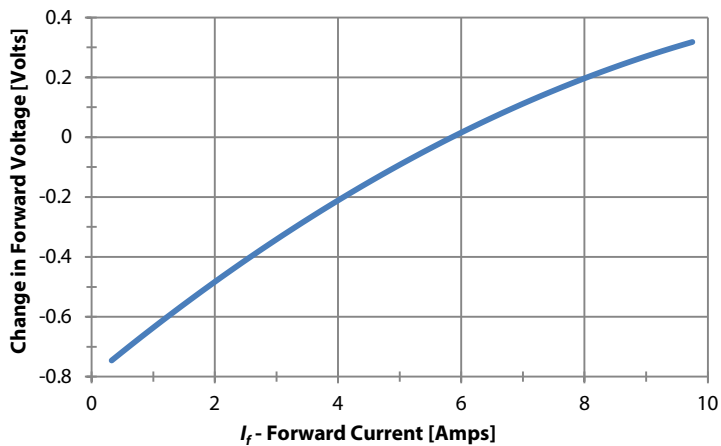
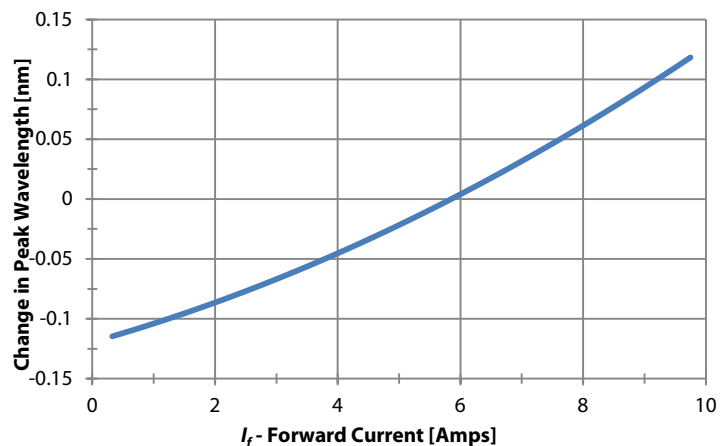
**Optical & Electrical Characteristics**
**Relative Power vs Forward Current ( $I_f$ ): Normalized to  $T_j = 120^\circ\text{C}$  and  $I_f = 6\text{ A}$** 
**405 nm**

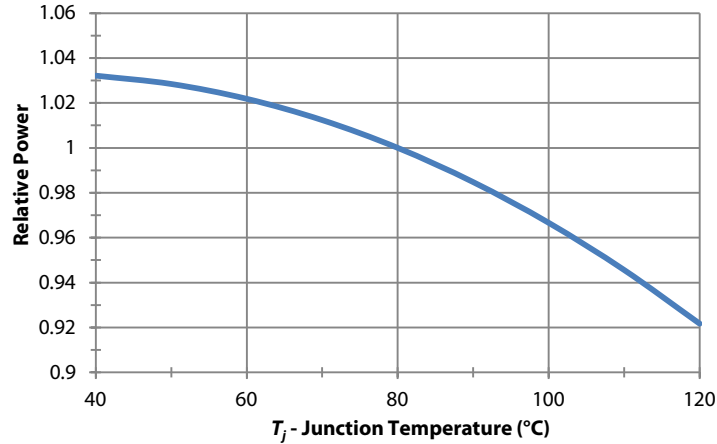
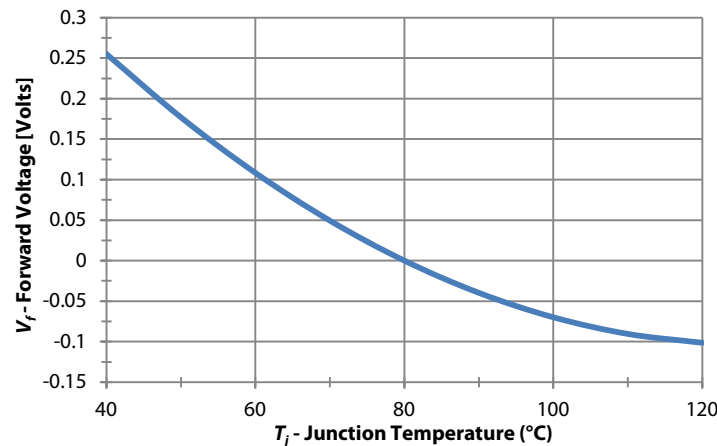
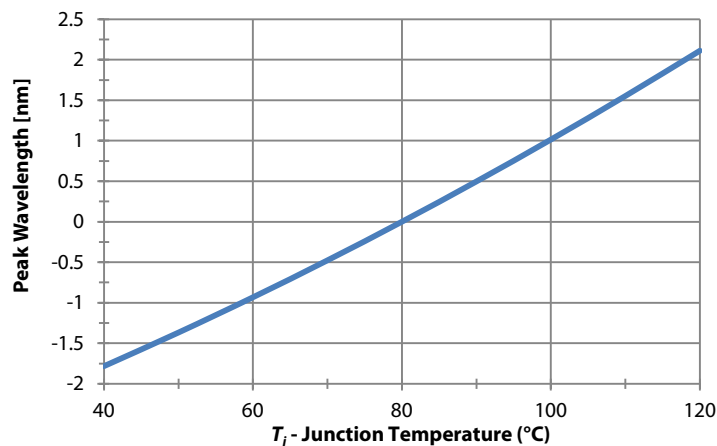
**Change in Forward Voltage vs Forward Current ( $I_f$ ): Normalized to  $T_j = 120^\circ\text{C}$  and  $I_f = 6\text{ A}$** 
**405 nm**

**Change in Centroid Wavelength vs Forward Current ( $I_f$ ): Normalized to  $T_j = 120^\circ\text{C}$  and  $I_f = 6\text{ A}$** 
**405 nm**

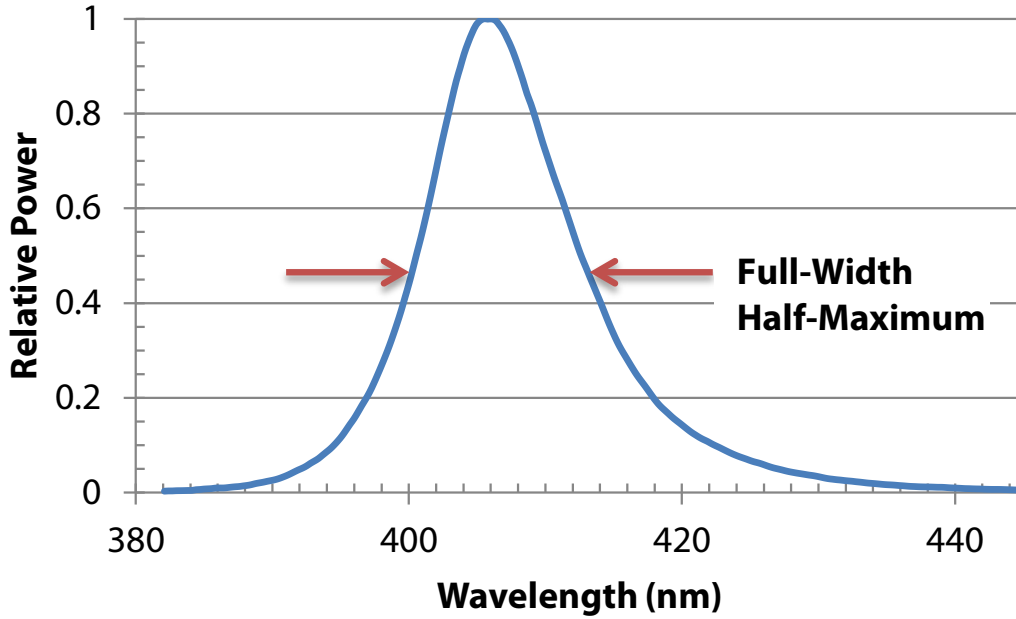
**Optical and Electrical Characteristics vs  $T_j$  [°C]**
**Relative Power vs  $T_j$ : Normalized to  $I_f = 6$  A and  $T_j = 80^\circ\text{C}$**   
 405 nm

**Forward Voltage vs  $T_j$ : Normalized to  $I_f = 6$  A and  $T_j = 80^\circ\text{C}$**   
 405 nm

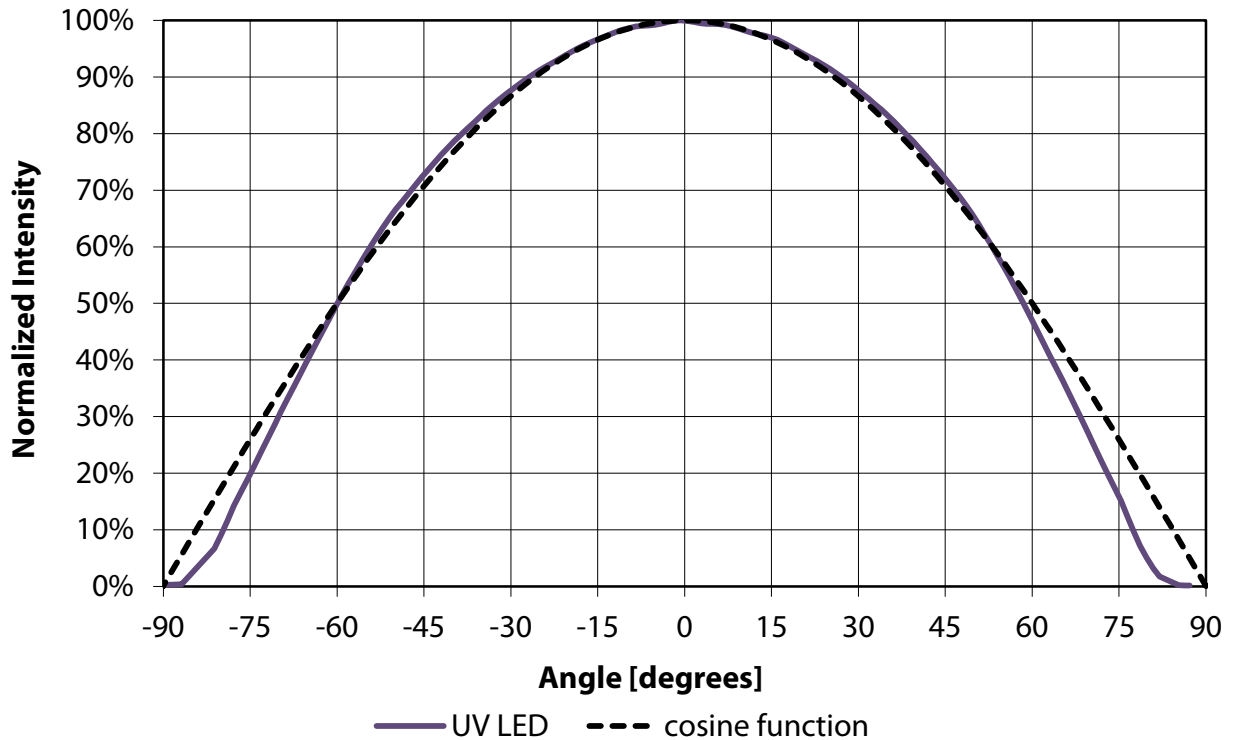
**Peak Wavelength vs  $T_j$ : Normalized to  $I_f = 6$  A and  $T_j = 80^\circ\text{C}$**   
 405 nm

### Optical Spectrum (Typical)



### Angular Intensity Distribution (Typical)



## Thermal Resistance

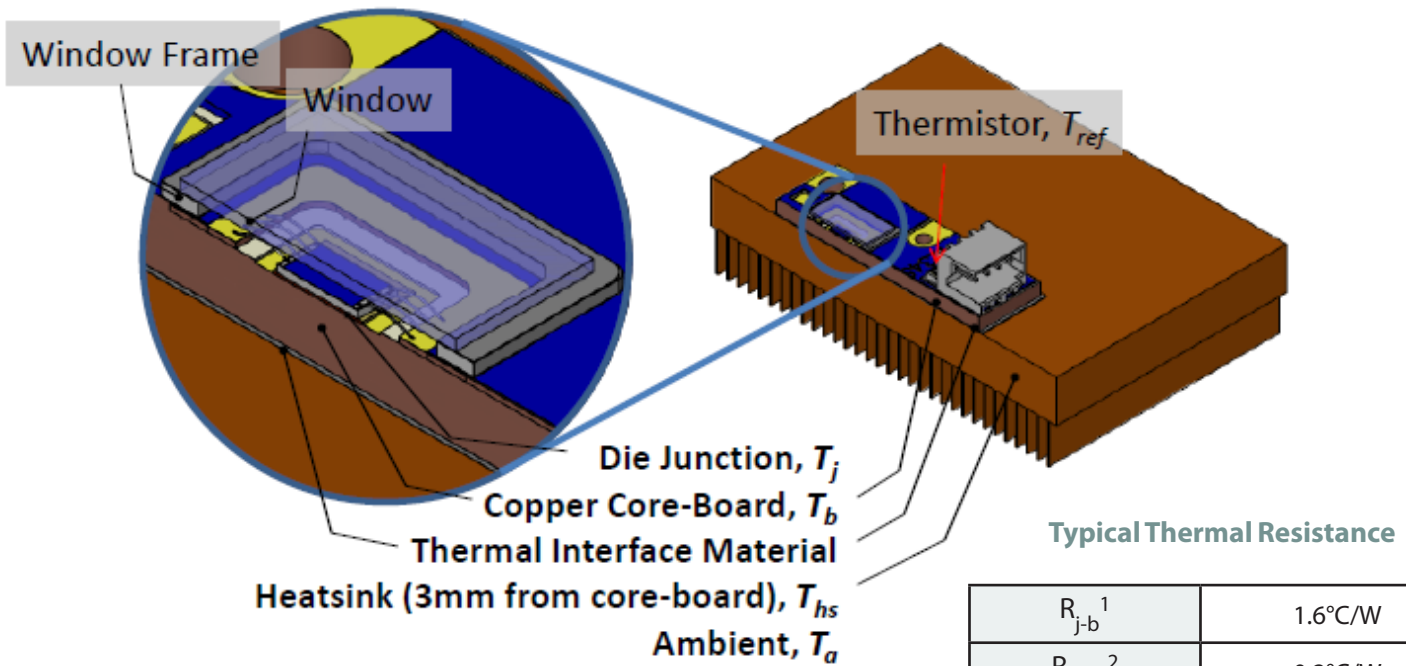

Note 1: Thermal resistance values are preliminary and are based on modeled results correlated to measured  $R_{j-hs}$  data using the wavelength shift method. Verification of compliance with the recent releases of JEDEC Standards JESD51-14 and JESD51-5x series is pending.

Note 2: Thermal Resistance is based on eGraf 1205 Thermal interface.

## Thermistor Information

The thermistor used in CBT-39 devices are mounted on coreboards is from Murata Manufacturing Co. The global part number is NCP18XH103J03RB. Please see <http://www.murata.com/> for details on calculating thermistor temperature.

For more information on use of the thermistor, please contact Luminus directly.

## Electrical Pinout

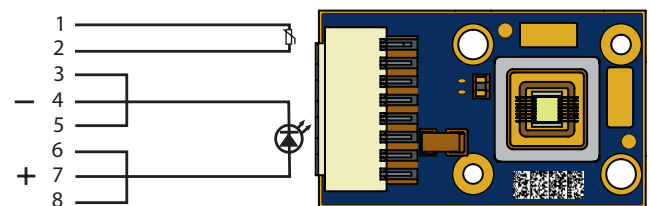



**Mechanical Dimensions - Monolithic Window and Frame<sup>1</sup>**

DIMENSIONS IN MILLIMETERS

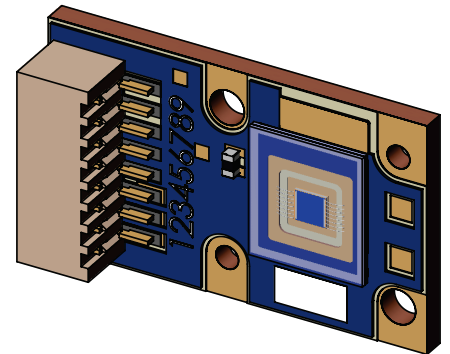
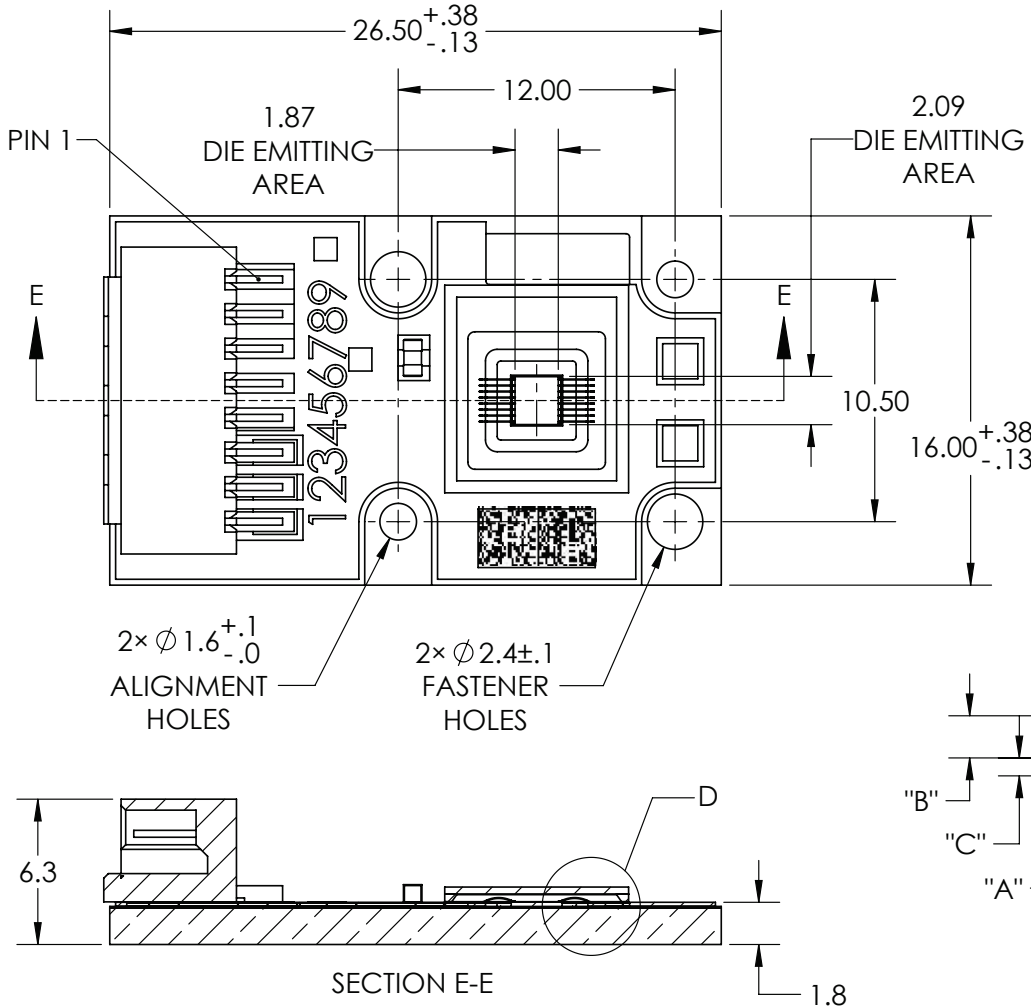

PIN NO.	FUNCTION
1	THERMISTOR (+)
2	THERMISTOR (-)
3-5	CATHODE (-)
6-8	ANODE (+)

DIMENSION NAME	DESCRIPTION	NOMINAL DIMENSION	TOLERANCE
"A"	TOP OF METAL SUBSTRATE TO TOP OF WINDOW	.91	±.13
"B"	TOP OF DIE EMITTING AREA TO TOP OF WINDOW	.64	±.11
"C"	TOP OF METAL SUBSTRATE TO TOP OF DIE EMITTING AREA	.27	±.02

DWG-002071

- Connector- MOLEX Part Number: 874380843 or Global Part Number: WTB16-081SF. Please refer to DWG-001703 (separate document) for pin-out information

Note 1: The monolithic window shown in this drawing is replaced by the discrete window and frame design shown next page and Luminus may ship either version. Both use the same window material and have the same optical properties. Slight differences in the window and frame dimensions are summarized page 10.

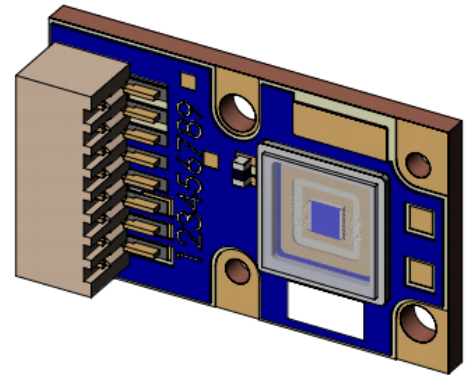
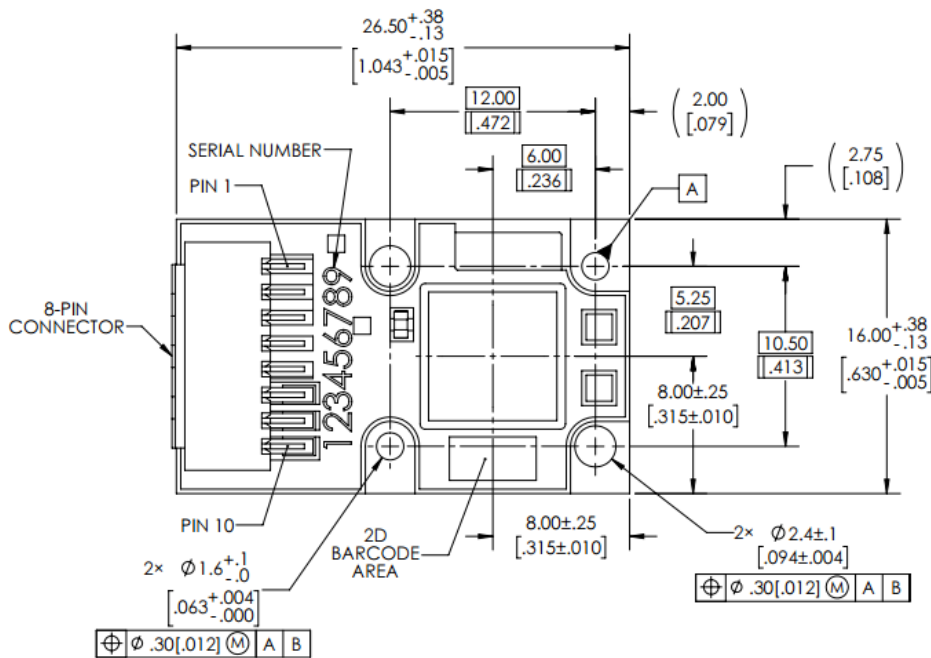
**Mechanical Dimensions - Discrete Window and Frame**

PIN ASSIGNMENT	
PIN NO(S).	ASSIGNMENT
1	THERMISTOR (+)
2	THERMISTOR (-)
3-5	CATHODE (-)
6-8	ANODE (+)

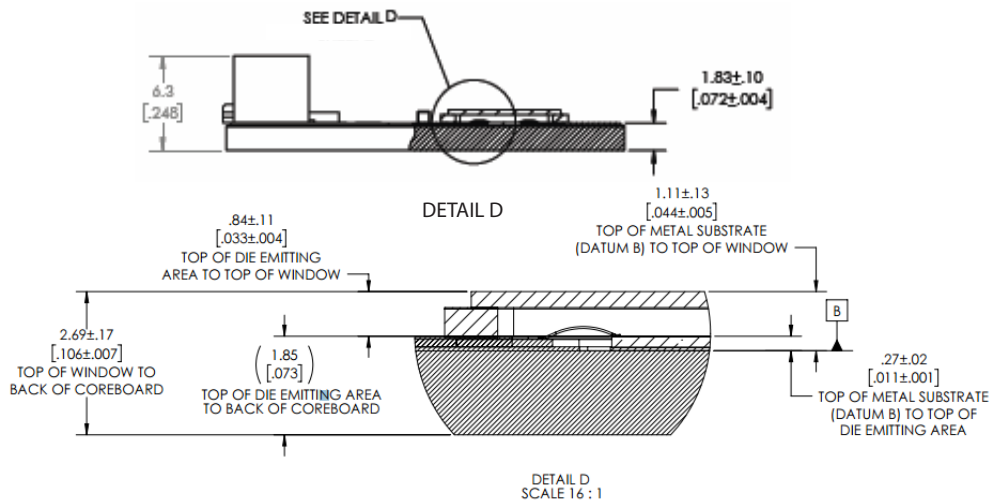

- Connector- MOLEX Part Number: 874380843 or Global Part Number: WTB16-081SF. Please refer to DWG-001703 (separate document) for pin-out information

Note 1: Dimensions are in millimeters [inches]. Reference Luminus drawing DWG-002922.

**Dimensional Comparison of Monolithic vs. Discrete Window and Frame**

Dimension	Monolithic	Discrete
Horizontal (X,Y)	9.00 mm x 7.97 mm	8.50 mm x 8.50 mm
Top of die emitting area to top of window	0.8 mm	0.77 mm
Top of window to back of coreboard	2.49 mm	2.46 mm

### History of Changes

Rev	Date	Description of Change
PDS-002169 Rev 04	05/26/2017	Add higher flux bins. Update typical power. Move ordering information to page 3. Added discrete window and frame dimensions



The products, their specifications and other information appearing in this document are subject to change by Luminus Devices without notice. Luminus Devices assumes no liability for errors that may appear in this document, and no liability otherwise arising from the application or use of the product or information contained herein. None of the information provided herein should be considered to be a representation of the fitness or suitability of the product for any particular application or as any other form of warranty. Luminus Devices' product warranties are limited to only such warranties as accompany a purchase contract or purchase order for such products. Nothing herein is to be construed as constituting an additional warranty. No information contained in this publication may be considered as a waiver by Luminus Devices of any intellectual property rights that Luminus Devices may have in such information.

This product is protected by U.S. Patents 6,831,302; 7,074,631; 7,083,993; 7,084,434; 7,098,589; 7,105,861; 7,138,666; 7,166,870; 7,166,871; 7,170,100; 7,196,354; 7,211,831; 7,262,550; 7,274,043; 7,301,271; 7,341,880; 7,344,903; 7,345,416; 7,348,603; 7,388,233; 7,391,059 Patents Pending in the U.S. and other countries.